

2SA1386/1386A

Silicon PNP Epitaxial Planar Transistor (Complement to type 2SC3519/A)

Application : Audio and General Purpose

Absolute maximum ratings (Ta=25°C)

Symbol		Unit
VcBo		V
VcEo		V
VEBo	-5	V
Ic	-15	A
Ib	-4	A
Pc	130(Tc=25°C)	W
Tj	150	°C
Tstg	-55 to +150	°C

Electrical Characteristics (Ta=25°C)

Symbol	Conditions	2SA1386	2SA1386A	Unit
IcBo	VcB=	-100max	-100max	μA
VEBo	VEB=-5V	-160	-180	V
Ic	VEB=-5V	-100max	-100max	μA
V(BR)CEO	Ic=-25mA	-160min	-180min	V
hFE	VCE=-4V, Ic=-5A	50min*		
VCE(sat)	Ic=-5A, Ib=-0.5A	-2.0max		V
fT	VCE=-12V, IE=2A	40typ		MHz
COB	VcB=-10V, f=1MHz	500typ		pF

*hFE Rank O(50 to 100), P(70 to 140), Y(90 to 180)

External Dimensions MT-100(TO3P)

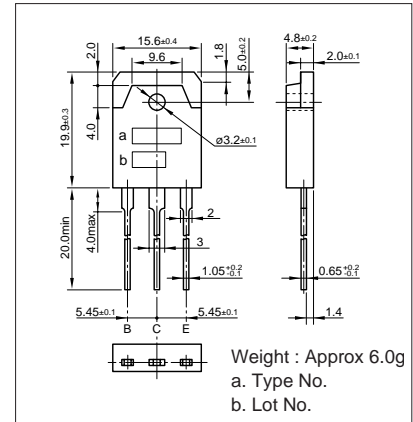

Typical Switching Characteristics (Common Emitter)

VCC (V)	RL (Ω)	Ic (A)	VBB1 (V)	VBB2 (V)	IB1 (A)	IB2 (A)	ton (μs)	tstg (μs)	tf (μs)
-40	4	-10	-10	5	-1	1	0.3typ	0.7typ	0.2typ

Ic-VCE Characteristics (Typical)

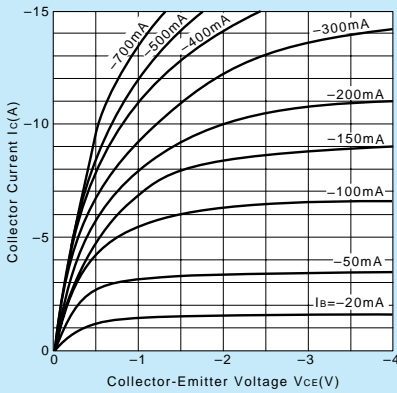

VCE(sat)-Ib Characteristics (Typical)

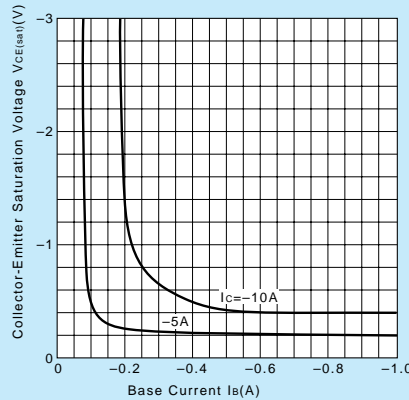

Ic-VBE Temperature Characteristics (Typical)

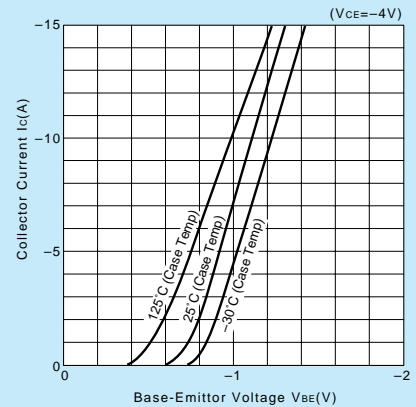

hFE-Ic Characteristics (Typical)

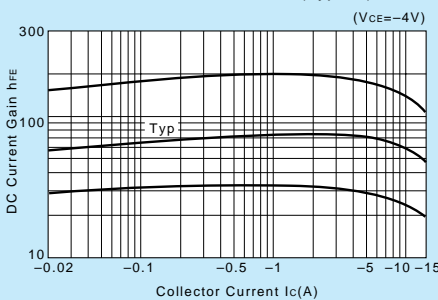

hFE-Ic Temperature Characteristics (Typical)

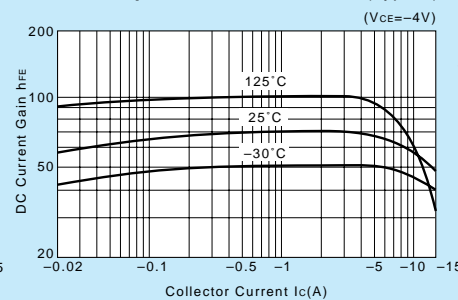

θj-a-t Characteristics

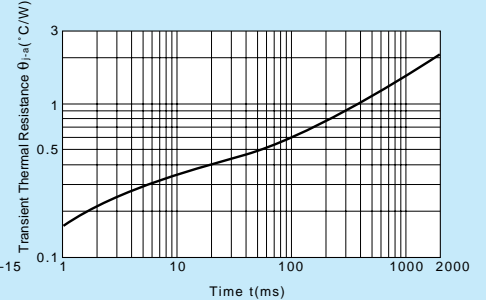

fT-IE Characteristics (Typical)

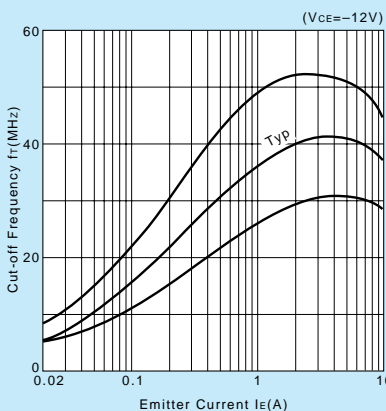

Safe Operating Area (Single Pulse)

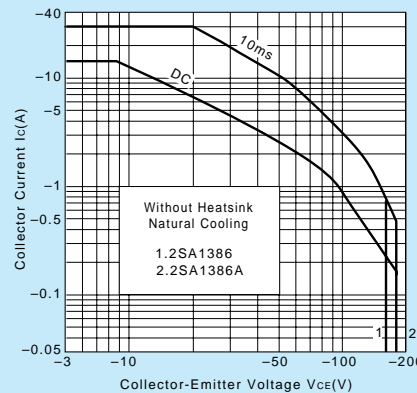

Pc-Ta Derating

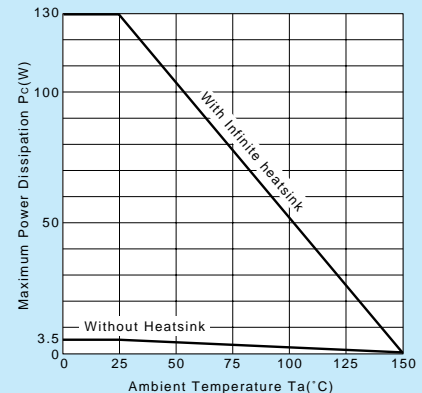

2SC3519/3519A

Silicon NPN Epitaxial Planar Transistor (Complement to type 2SA1386/A)

Application : Audio and General Purpose

Absolute maximum ratings (Ta=25°C)

Symbol	2SC3519	2SC3519A	Unit
V _{CB0}	160	180	V
V _{CE0}	160	180	V
V _{EBO}	5		V
I _C	15		A
I _B	4		A
P _C	130(T _C =25°C)		W
T _J	150		°C
T _{stg}	-55 to +150		°C

Electrical Characteristics

Symbol	Unit
I _{CE0}	100max μ A
V _{CE(sat)}	2.0max V
f _T	50typ MHz
C _{ic}	250typ pF

Typical Switching Characteristics (Common Emitter)

V _{CC} (V)	R _L (Ω)	I _C (A)	V _{BB1} (V)	V _{BB2} (V)	I _{B1} (A)	I _{B2} (A)	t _{on} (μ s)	t _{stg} (μ s)	t _r (μ s)
40	4	10	10	-5	1	-1	0.2typ	1.3typ	0.45typ

External Dimensions MT-100(TO3P)

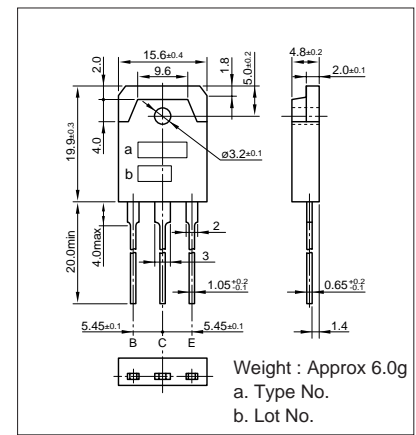

I_C-V_{CE} Characteristics (Typical)

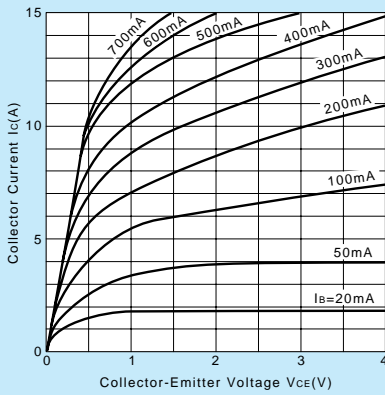

V_{CE(sat)}-I_B Characteristics (Typical)

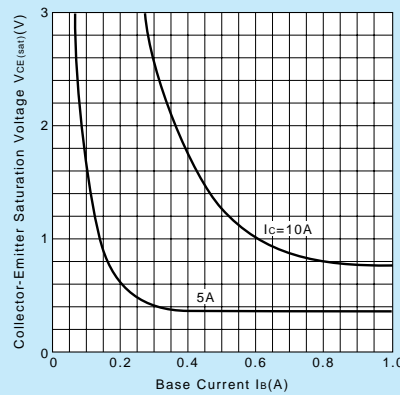

I_C-V_{BE} Temperature Characteristics (Typical)

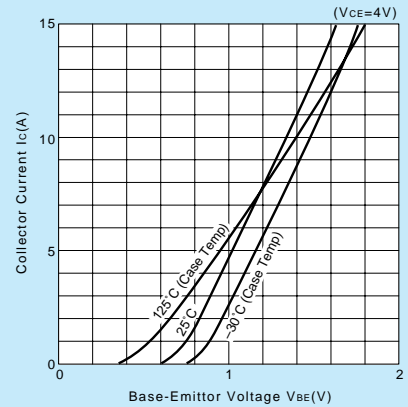

h_{FE}-I_C Characteristics (Typical)

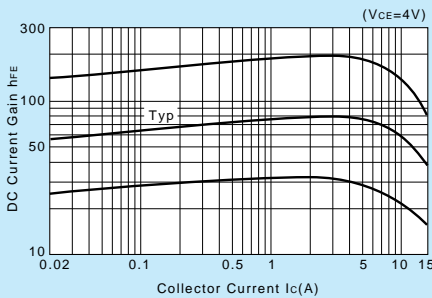

h_{FE}-I_C Temperature Characteristics (Typical)

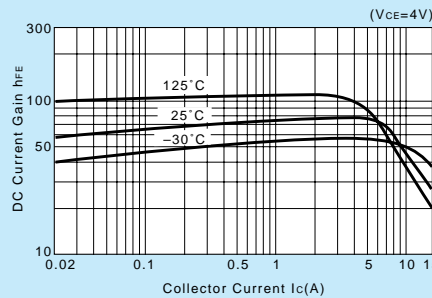

θ_{j-a-t} Characteristics

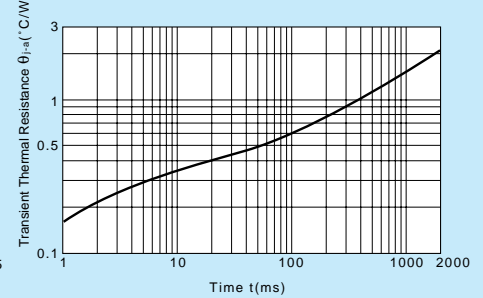

f_T-I_E Characteristics (Typical)

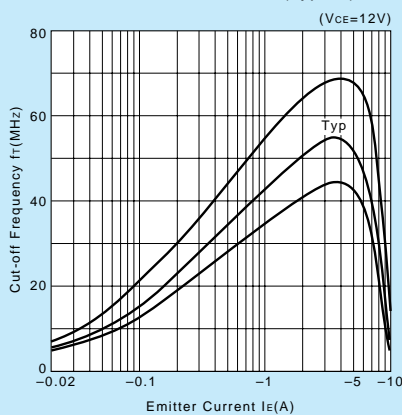

Safe Operating Area (Single Pulse)

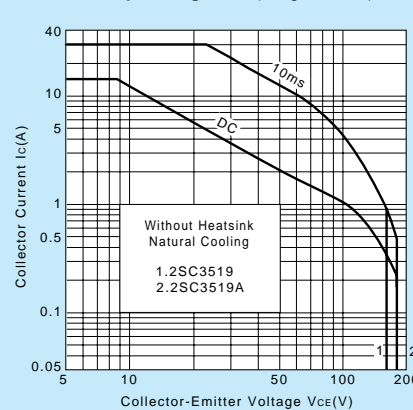

P_C-T_a Derating

